

AP900

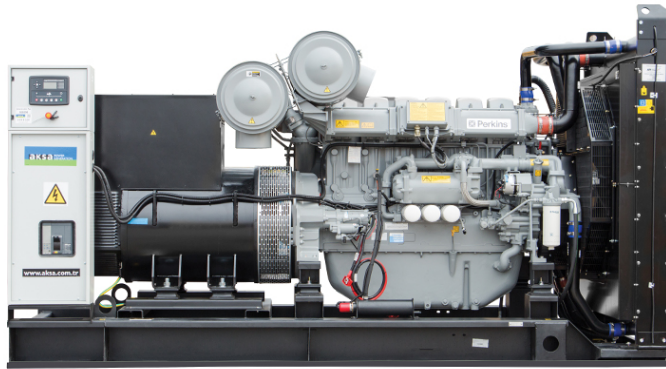

**POWER
YOUR
FUTURE**

**900KVA / 720KW
POWERED by PERKINS**

DIESEL GENERATING SET 400/230 V - 50 Hz

MODEL			AP900
Power Pf. 0.8	Standby	kVA	900
		kW	720
	Prime	kVA	810
		kW	648

Standby: Continuous running at variable load for duration of an emergency. No overload is permitted on these ratings. In accordance with ISO 3046 .
Prime: Continuous running at variable load for unlimited periods with 10% overload available for 1 hour in any 12 hour period. In accordance with ISO 8528,ISO 3046.

- ✓ High quality, reliable and complete power unit
- ✓ Compact design
- ✓ Easy start and maintenance possibility
- ✓ Every generating set is subject to a comprehensive test program which includes full load testing, checking and provision of all control and safety shut down functions testing
- ✓ Fully engineered with a wide range of options and accessories: Canopy, sound proof canopy and on-road trailer



Manufacturer reserves the right to make changes in model, technical specifications, color, equipment and accessories without prior notice.

ENGINE

PERKINS		
Model		4006-23TAG3A
Engine Power Output at rated rpm	kWm	786
	HP	1054
Aspiration and Cooling		Turbocharged
Total Displacement	Litre	22,921
No. of Cylinders and Build		6; vertical in-line
Engine Speed	rpm	1500
Bore and Stroke	mmxmm	160×190
Compression Ratio		13.6:1
Governor		Electronic
Fuel Consumption at full load	L/hr	172
Fuel Tank Capacity	Litre	open: N/A / canopy:1100
Oil Capacity	Litre	113.4
Coolant Capacity	Litre	120
Radiator Cooling Air	m ³ /min	1200
Air Intake – Engine	m ³ /min	73
Exhaust Gas Flow	m ³ /min	193

- ✓ Heavy duty Perkins diesel engine
- ✓ Four stroke, water cooled, turbocharged
- ✓ Direct injection fuel system
- ✓ Electronic Governor system
- ✓ 12/24 V D.C. starter and charge alternator
- ✓ Replaceable fuel filter, oil filter and dry element air filter
- ✓ Cooling radiator and fan
- ✓ Starter battery (with lead acid) including Rack and Cables
- ✓ Flexible fuel connection hoses and manual oil sump drain valve
- ✓ Industrial capacity exhaust silencer and steel bellows
- ✓ Jacket water heater(at automatic models)
- ✓ Operation manuals and circuit diagram documents

ALTERNATOR

Design	Brushless single bearing, revolving field
Stator	2/3 pitch
Rotor	Single bearing, flexible disc
Insulation System	Class H
Standard Temperature Rise	105 - 130°C Continuous
Exciter Type	Self Excited
Phase Rotation	A (U), B (V), C (W)
Alternator Cooling	Direct drive centrifugal blower fan
AC Waveform Total Harmonic Distortion	No load < 1.5%. Non distorting balanced linear load < 5%
Telephone Influence Factor (TIF)	<50 per NEMA MG1-22.43
Telephone Harmonic Factor (THF)	<2%

- ✓ Brushless, single bearing system, flexible disc, 4 poles
- ✓ Insulation class H
- ✓ Standard degree of protection IP21 (*IP22/IP23 is available.)
- ✓ Self-exciting and self-regulating
- ✓ Impregnation with tropicalised epoxy varnish
- ✓ Solid state Automatic Voltage Regulator
- ✓ Stator winding with 2/3 pitch for improved harmonics

CONTROL SYSTEM

Control supervision and protection panel is mounted on the genset base frame. The control panel is equipped as follows:

1. Auto Mains Failure Control Panel

Panel equipments:

- ✓ Control with AMF module
- ✓ Static battery charger
- ✓ Emergency stop push button

a) Generating set control module DSE 7320 features:

- ✓ The module is used to monitor a mains supply and starts and stops a standby generating set
- ✓ Micro-processor based design
- ✓ Automatic control of mains and generator contactors
- ✓ Monitors engine performance and AC power output
- ✓ LED alarm indication
- ✓ Front panel configuration of timers and alarm trip points
- ✓ Easy push button control
STOP/RESET - MANUAL - TEST- AUTO - MUTE ALARM - START

b) Metering via LED display:

- ✓ Generator Volts (L-L / L-N)
- ✓ Engine oil pressure (PSI-Bar)
- ✓ Generator Ampere (L1,L2,L3)
- ✓ Engine temperature (° C & ° F)
- ✓ Generator Frequency (Hz)
- ✓ Plant battery volts
- ✓ Engine hours run
- ✓ Mains Volts (Ph-Ph/Ph-N)
- ✓ Generator kVA, kWh
- ✓ Generator kW as % of rated kW setting
- ✓ Generator Cos (σ)

2. Power Outlet Terminal Board Mounted on the Genset Base Frame



DSE 7320

c) Alarms:

- ✓ Over and Under Speed
- ✓ Low and High Battery Volt.
- ✓ Start and Stop Failure
- ✓ Charge fail
- ✓ Over Current
- ✓ Under / Over Generator Voltage
- ✓ Low Oil Pressure
- ✓ Emergency stop
- ✓ High engine temperature
- ✓ kW overload
- ✓ Unbalanced load
- ✓ Independent earth fault trip

d) LED indications

Four configurable LED's like:

- ✓ Mains available
- ✓ Generator available
- ✓ Mains on load
- ✓ Generator on load

OPTIONAL EQUIPMENTS

Diesel Engine

- ✓ Oil heater

Alternator

- ✓ 3/4 Pole Output Circuit Breaker
- ✓ Anti-condensation Heater

Panel

- ✓ Charge ammeter
- ✓ Transfer Switch 3 Pole
- ✓ Transfer Switch 4 Pole
- ✓ Earth Fault ,single set

Accessories

- ✓ Bulk fuel tank
- ✓ Automatic filling system
- ✓ Fuel-water separator filter
- ✓ Low fuel level alarm
- ✓ Residential silencer
- ✓ Enclosure or sound proof canopy
- ✓ Trailer
- ✓ Manual oil drain pump
- ✓ Tool kit for maintenance

CHASSIS

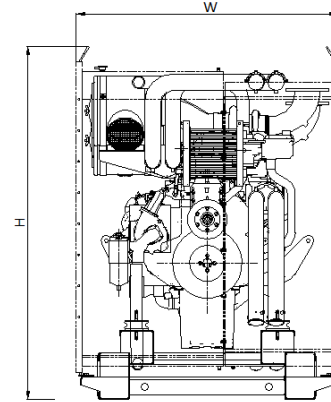
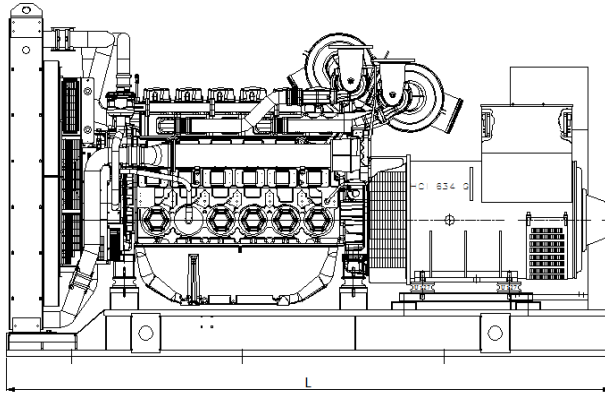

- ✓ The complete gen-set is mounted as whole on a heavy-duty fabricated, steel base frame
- ✓ Anti-vibration pads are fixed between the engine/ alternator feet and the base frame
- ✓ Base frame design incorporates an integral fuel tank (Up to 750 kVA)
- ✓ The generating set can be lifted or carefully pushed / pulled by the base frame
- ✓ Dial type fuel gauge and drain plug on the fuel tank
- ✓ Forklift pockets within base frame (up to 500kVA)

DIMENSIONS

OPEN TYPE

DIMENSIONS (LxWxH)	mm	3900*1690*2270
DRY WEIGHT	kg	6250

SOUND ATTENUATED TYPE

DIMENSIONS (LxWxH)	mm	5920*2200*(2350+1000)
DRY WEIGHT	kg	7650

CANOPY

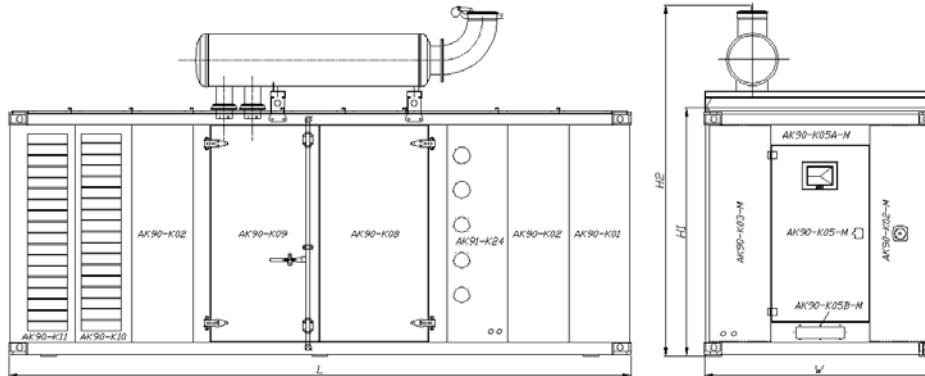

- ✓ All canopy parts are designed with modular principles
- ✓ Without welding assembly
- ✓ Doors on each side
- ✓ All metal canopy parts are painted by electrostatic polyester powder paint
- ✓ Exhaust silencer is protected against environment influences
- ✓ Thermally insulated engine exhaust system
- ✓ Emergency stop push button is installed outside of the canopy
- ✓ Easy lifting and moving
- ✓ Easy maintenance and operation